

TRANSFORMERS GENERATIONS

FORMERS



ULTRA MAGNUS™
FALL OF CYBERTRON™

NOTE: Some parts are made to detach if excessive force is applied, and are designed to be reattached if separation occurs. Adult supervision may be necessary for younger children.



WARNING:

CHOKING HAZARD—Small parts.
Not for children under 3 years.

AGES 5+

A1427/37986 Asst.

LEVEL: 0 1 2 3
INTERMEDIATE

CHANGING TO VEHICLE

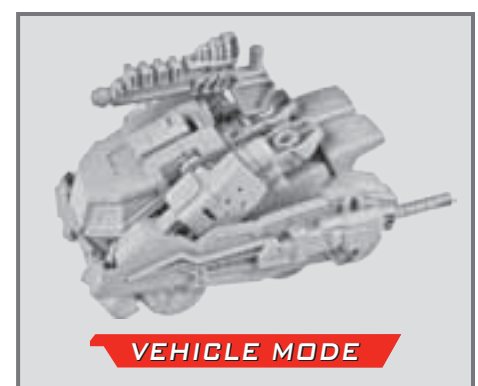
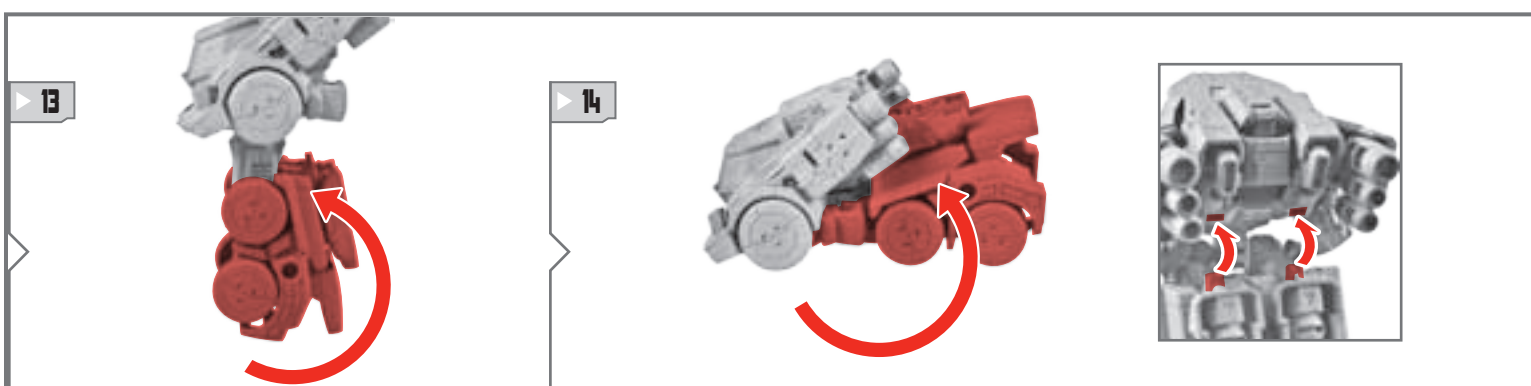
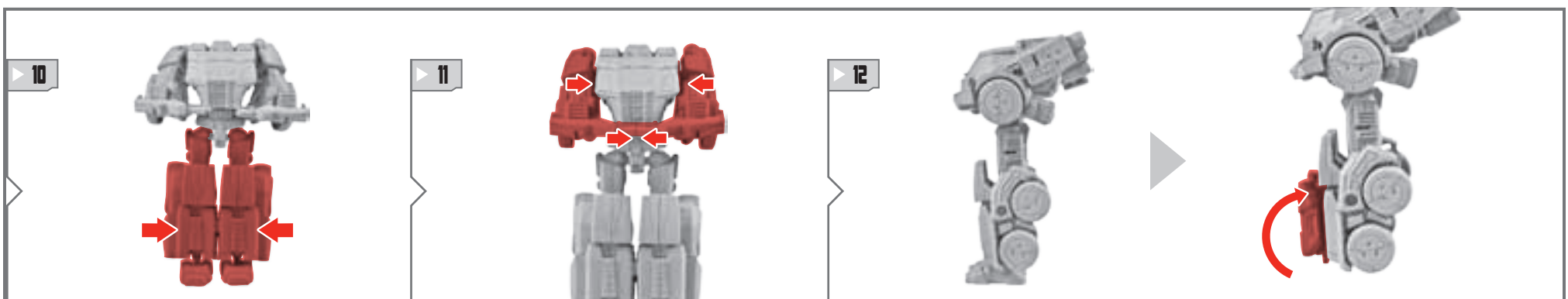
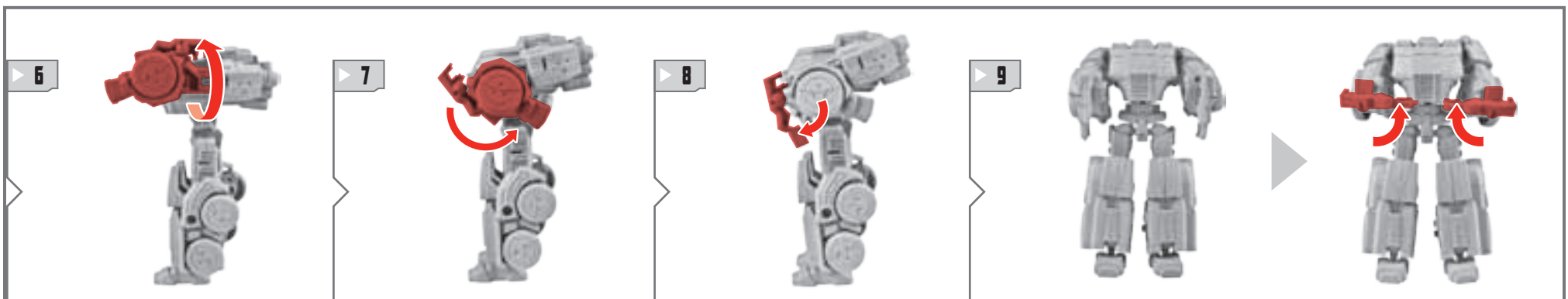
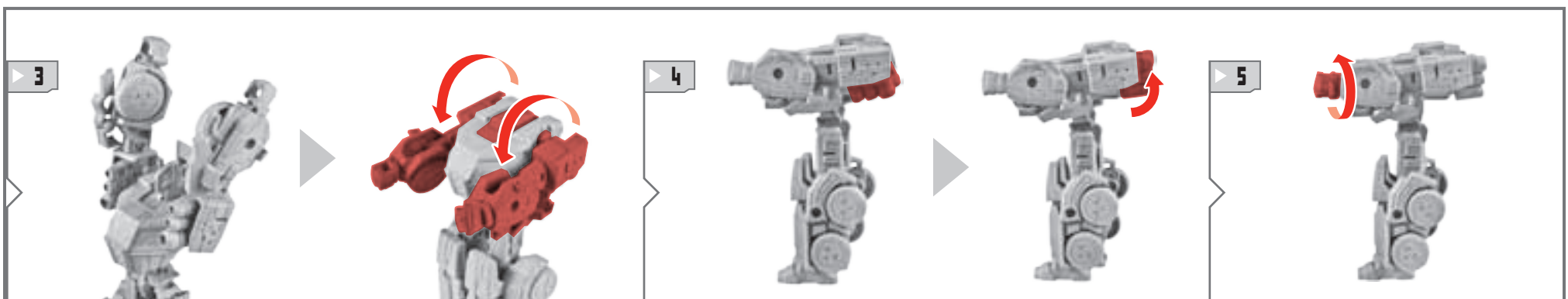
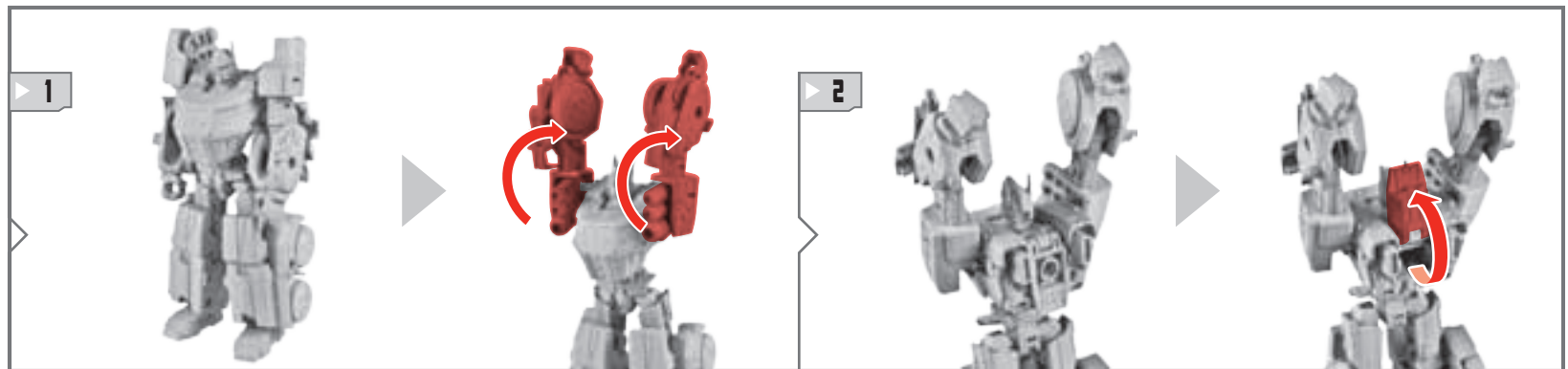

VEHICLE MODE

CHANGING TO ROBOT

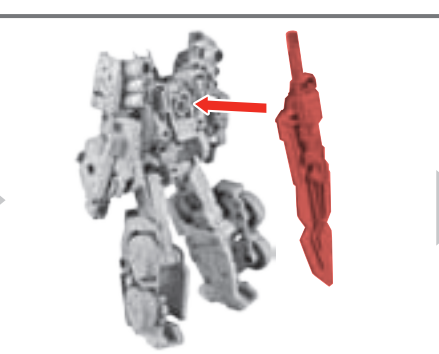
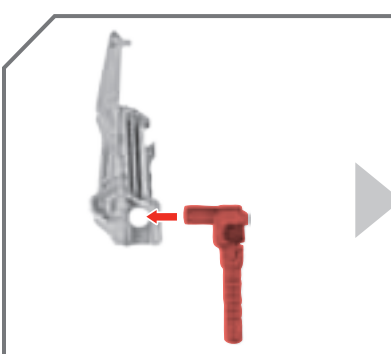
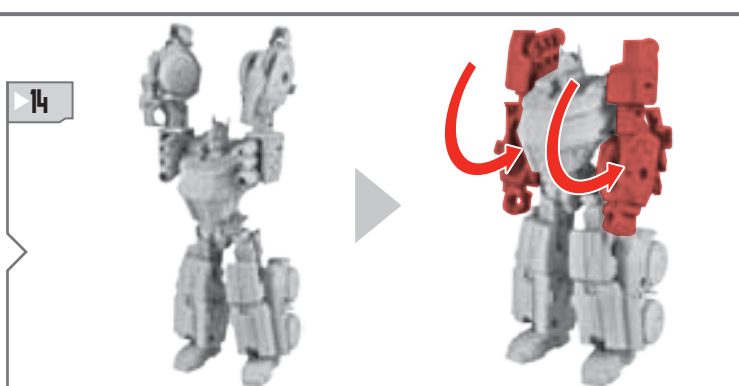
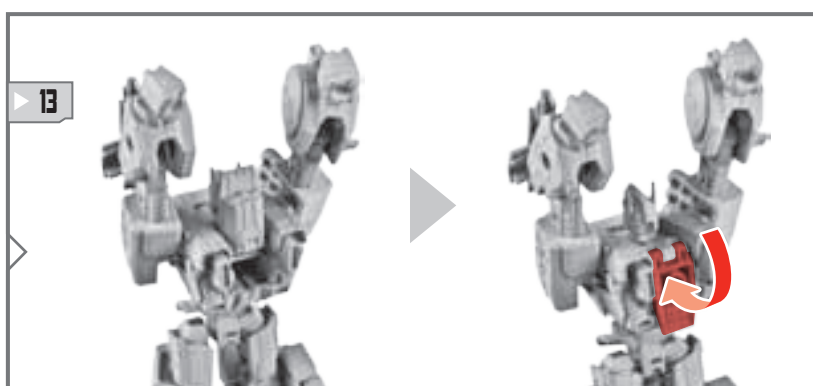
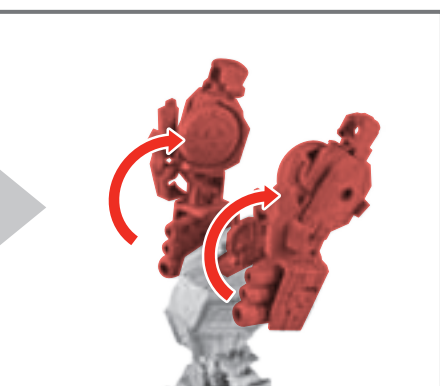
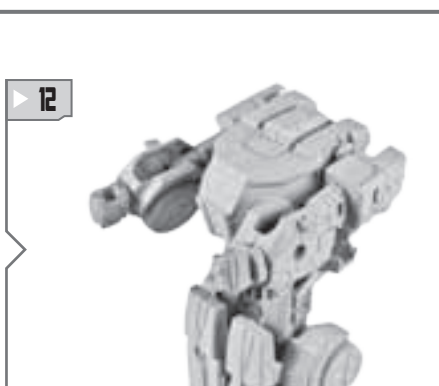
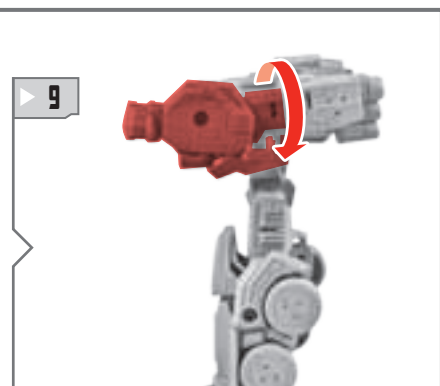
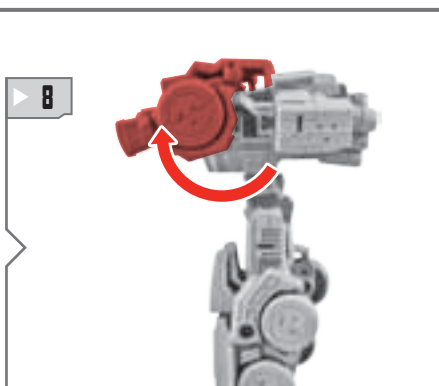
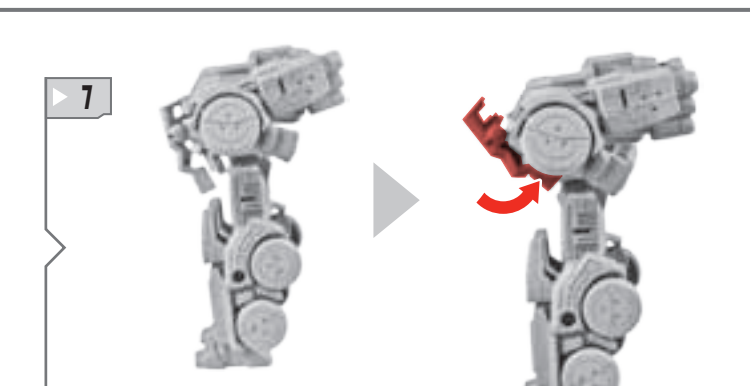
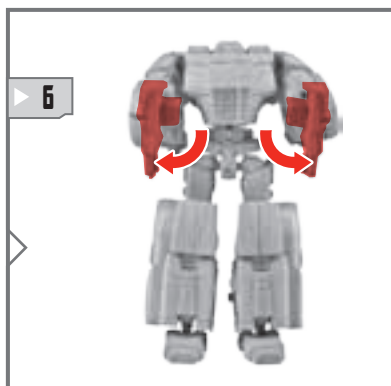
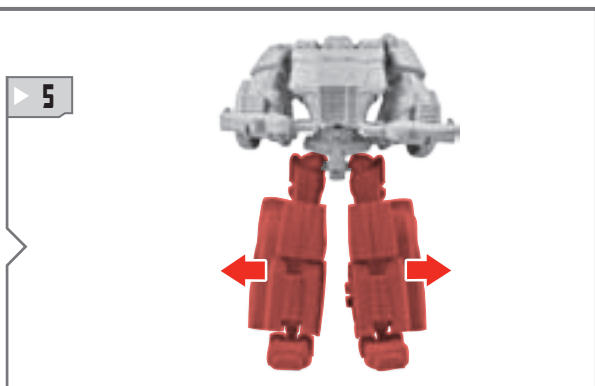
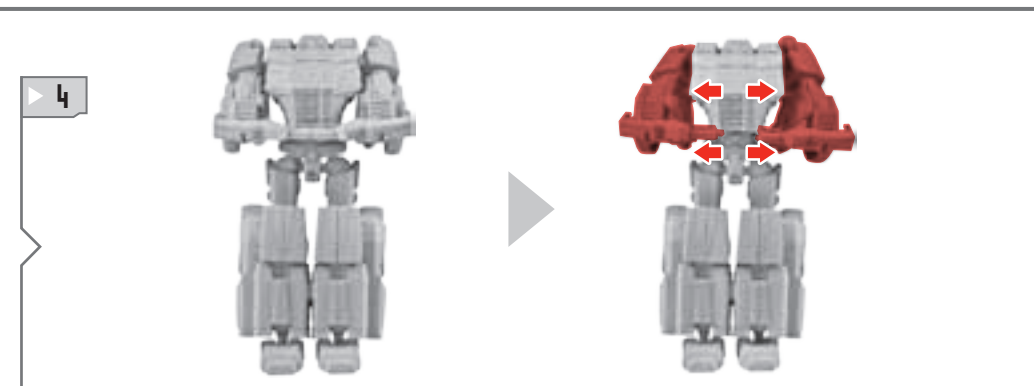
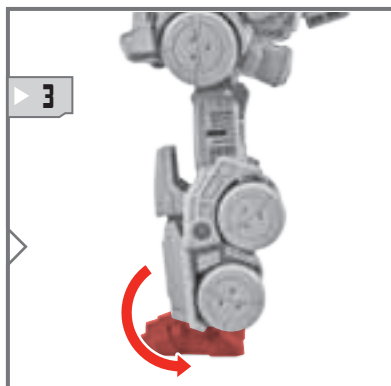
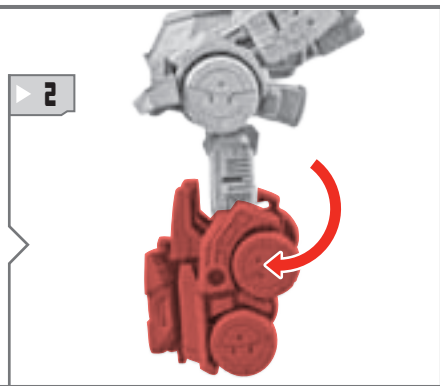
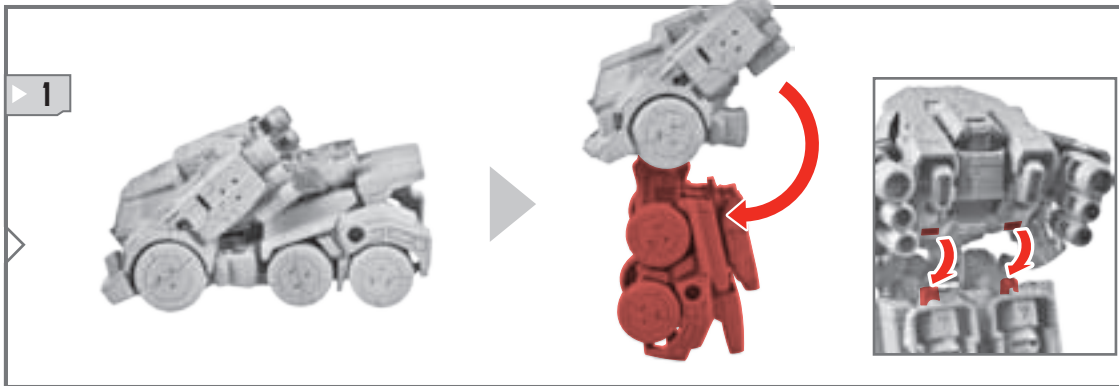

Retain instructions for future reference.
 Product and colors may vary. Some poses may require hand support.
 Manufactured under license from TOMY Company, Ltd.
 © 2012 Hasbro. All Rights Reserved. TM & © denote U.S. Trademarks.

P/N 7296320000

TRANSFORMERS.COM/INSTRUCTIONS



Customer Code: 5008/A1427_37986_TRA_GD_UltMag.indd
 2011-06-0376/Terry/2011-06-20/EP1_CT-Coated

源能設計制作(深圳)有限公司
www.artechgraphics.com.hk | info@artechgraphics.com.hk | Tel 755-3322 8070

K 485



485C